



Diavia

FIAT DUCATO 3.0 MJT
(Serie X250) "157 HP" *EURO4*

CITROEN JUMPER 3.0 HDi
"157 HP" *EURO4*

PEUGEOT BOXER 3.0 HDi
"157 HP" *EURO4*

Codice/Code: 1FI34300E

**Istruzioni montaggio
condizionatore d'aria**

**Instructions pour monter le
conditionneur d'air**

**Air conditioning
installation instructions**

**Klimaanlage
Einbauanleitungen**

**Instrucciones para el montaje
del equipo aire acondicionado**

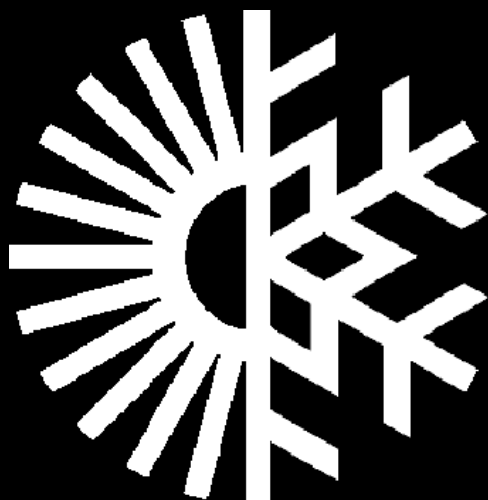

**DESCRIZIONE SIMBOLOGIA UTILIZZATA / DESCRIPTION DE LA SYMBOLOGIE UTILISÉE
DESCRIPTION OF SYMBOLS USED / BESCHREIBUNG DER VERWENDETEN SYMBOLIK
DESCRIPCIÓN DE LOS SIMBOLOS UTILIZADOS**

1A Riferimento a figura / Référence à la figure / See figure
In Bezug auf Abbildungen / Referencia a la figura

1- 1 Riferimento a componenti di fornitura / Référence aux composants de la fourniture
See supplied components / Bezug auf Gelieferte Einbauelemente
Referencia a los componentes de abastecimiento

1 Riferimento a posizione schema elettrico / Référence à la position du schéma électrique
See position in wiring diagram / In Bezug auf Position im Schaltschema /
Referencia a la posición del esquema eléctrico



- Lubrificare tutti i raccordi e gli O.R. con il nuovo olio refrigerante prima di collegarli

- Graisser tous les raccords et les O.R. avec le nouveau huile réfrigérant avant de les raccorder

-Lubricate all fittings and O-rings with new refrigerant oil before connecting them

- Alle Verbindungsstücke und OR-Ringe vor deren Verbindung mit dem neuen Kühlmittelöl ölen

- Lubrificar todos los empalmes y los O.R. con el nuevo aceite refrigerante antes de conectarlos

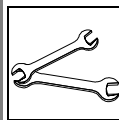

- Per avvitare a fondo o allentare i raccordi tubi gas usare due chiavi per bilanciare coppia di torsione

- Pour visser à fond ou desserrer les raccords des tuyaux gaz, utiliser le deux clés pour équilibrer le couple de torsion

- When tightening or loosening the fittings of the gas pipes, use two wrenches to equalize the torsion couple

- Um die Verbindungsstücke der Kältemittelschläuche gleichmäßig festzuschrauben oder zu lockern, zwei Schlüssel für das Verschraubungspaar verwenden

- Para enroscar a fondo o aflojar los empalmes tubos gas se deben usar dos llaves para balancear el par de torsión



- Tagliare con utensile appropriato al materiale

- Couper à l'aide d'outil approprié

- Cut with a device suitable for the material

- Mit dem Material entsprechendem Werkzeug schneiden

- Cortar con herramienta apropiada al material

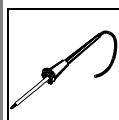

- Stagnare

- Étamer

- Tin

- Verzinnen

- Estañar



- Spianare

- Nivelar

- Flatten out

- Richten

- Nivelar

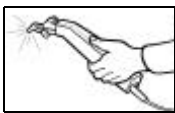

- Tagliare con utensile a lama calda

- Couper à l'aide d'un outil à lame chaude

- Cut using the tool with heated blade.

- Mit Schweißmesserwerkzeug schneiden

- Cortar con útil a hoja caliente

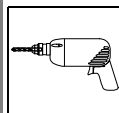

- Forare

- Percer

- To drill

- Durchbohren

- Taladrar

Pos.	ITALIANO	FRANÇAIS	ENGLISH	DEUTSCH	ESPAÑOL
31	Condensatore	Condenseur	Condenser	Kondensator	Condensador
32-62	Sacchetto accessori	Sachet accessoires	Bag of accessories	Säckchen mit Zuberhörteilen	Bolsita accesorios
33	Staffa destra di supporto condensatore	Etrier support condenseur droit	Right condenser support bracket	Kondensator-Haltebügel, rechts	Abrazadera derecha de soporte condensador
34	Staffa sinistra di supporto condensatore	Etrier support condenseur gauche	Left condenser support bracket	Kondensator-Haltebügel, links	Abrazadera izquierda de soporte condensador
35	Distanziale	Entretoise	Shim	Absandsstück	Distanziador
36	Supporto condensatore	Support condenseur	Condenser support	Kondensatorhalter	Suporte condensador
41	Sacchetto flangia	Sachet bride	Bag of flanges	Säckchen mit Flansch	Bolsita brida
42	Staffa di supporto tubi gas	Etrier support des tuyaux gaz	Gas pipe support bracket	Kältemittelschlauch Haltebügel	Abrazadera de soporte tubos gas
43-49	Fascetta in gomma	Collier en caoutchouc	Rubber clamp	Gummischele	Banda de goma
44-45	Fermatubo	Fixation tuyau	Pipe clamp	Schlauchbinder	Detiene tubo
46	Protezione a spirale	Protection en spirale	Spiral protection	Spiralförmige Ummantelung	Protección a espiral
47	Relay interruttore	Relais interrupteur	Switch relay	Relaisschalter	Relé interruptor
51	Filtro essiccatore	Filtre déshydrateur	Receiver drier	Trocknerfilter	Filtro secador
52	Staffa filtro	Etrier filtre	Receiver drier bracket	Filterbügel	Abrazadera filtro
61	Batteria evaporante	Batterie évaporateur	Evaporating unit	Verdampferbatterie	Batería evaporante
63	Distributore tubi gas	Distributeur tuyaux gaz	Gas pipe distributor	Kältemittelschlauchverteiler	Distribuidor tubos gas
64	Termostato	Thermostat	Thermostat	Thermostat	Termostato
65	Staffa supporto termostato	Etrier support thermostat	Thermostat support bracket	Thermostat-Haltebügel	Abrazadera soporte termostato
66	Molla fissaggio bulbo	Ressort fixation bulbe	Thermoswitch fixing spring	Kolben-befestigungsfeder	Muelle de fijación del bulbo
67	Pomello	Bouton	Knob	Drehkopf	Pomo
68	Mastice anticondensa	Mastic anti-condensation	Condensation-proofing material	Kondensatordichtungsmasse	Masilla anticondensación
69	Fascetta LOOPING	Collier LOOPING	Clamp LOOPING	Schelle LOOPING	Banda LOOPING
70	Tubo scarico condensa	Tuyau d'écoulement des condensations	Condensate drain pipe	Kondensatordrainrohr	Tubo descarga condensación
71	Valvola di espansione	Soupape d'expansion	Expansion valve	Expansionsventil	Válvula expansión
72	Flangia fissaggio valvola	Bride de fixation soupape	Valve fixing flange	Ventil-Befestigungsflansch	Brida de fijación de la válvula
	Tubo gas 5/16"CF (condensatore-filtro)	Tuyau gaz 5/16"CF (condenseur-filtre)	5/16"CF gas hose (condenser-filter)	5/16"CF kältemittelschlauch (Kondensator-Filter)	Tubo gas 5/16"CF (condensador-filtro)
	Tubo gas 5/16"FE (filtro-evaporatore)	Tuyau gaz 5/16"FE (filtre-évaporateur)	5/16"FE gas hose (filter-evaporator)	5/16"FE kältemittelschlauch (Filter-Verdampfer)	Tubo gas 5/16"FE (filtro-evaporador)
	Tubo gas 13/32"CC (compressore-condensatore)	Tuyau gaz 13/32"CC (compresseur-condenseur)	13/32"CC gas hose (compressor-condenser)	13/32"CC kältemittelschlauch (Kompressor-Kondensator)	Tubo gas 13/32"CC (compresor-condensador)
	Tubo gas 1/2"EC (evaporatore-compressore)	Tuyau gaz 1/2"EC (évaporateur-compresseur)	1/2"EC gas hose (evaporator-compressor)	1/2"EC kältemittelschlauch (Verdampfer-Kompressor)	Tubo gas 1/2"EC (evaporador-compresor)
	Fascetta a strappo	Bride auto-bloquant	Self-locking clamp	Selbstsichernde Schelle	Banda autobloqueante



**MONTAGGIO CONDENSATORE / POSE DU CONDENSEUR / CONDENSER FITTING
KONDENSATOREINBAU / MONTAJE CONDENSADOR**

MATERIALE FORNITO / MATERIEL FOURNI / SUPPLIED MATERIAL / GELIEFERTES MATERIAL / MATERIAL ABASTECIDO

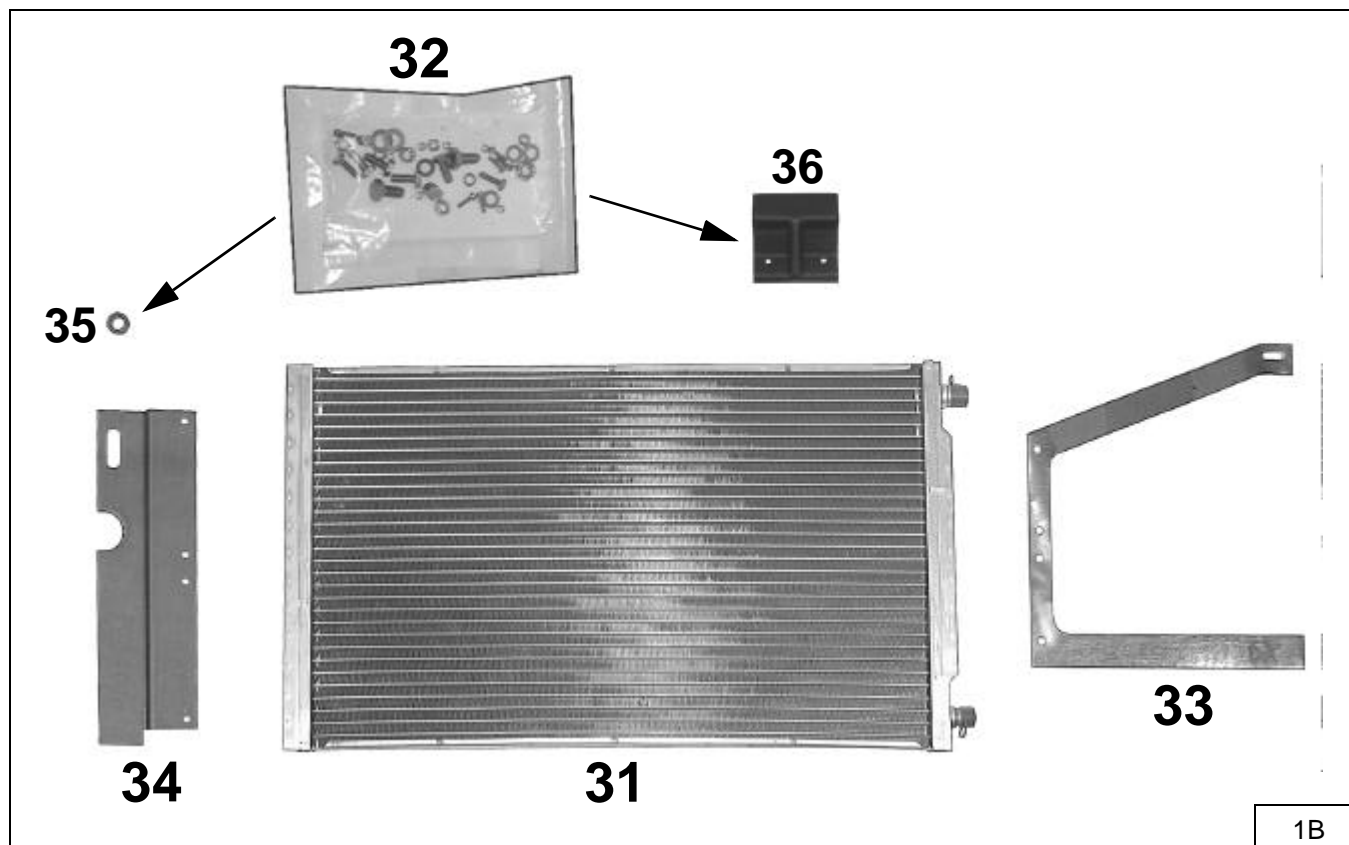

1B

Pos.	Descrizione / Description / Description Beschreibung / Descripción	Codice / Code Kode / Código
31	Condensatore	022301OR/1A
32	Sacchetto accessori	0231784/0
33	Staffa destra di supporto condensatore	0812869/0
34	Staffa sinistra di supporto condensatore	0812870/0
35	Distanziale $\phi 20 \times \phi 12 \times 9$	009966/0
36	Supporto condensatore	0322141/0

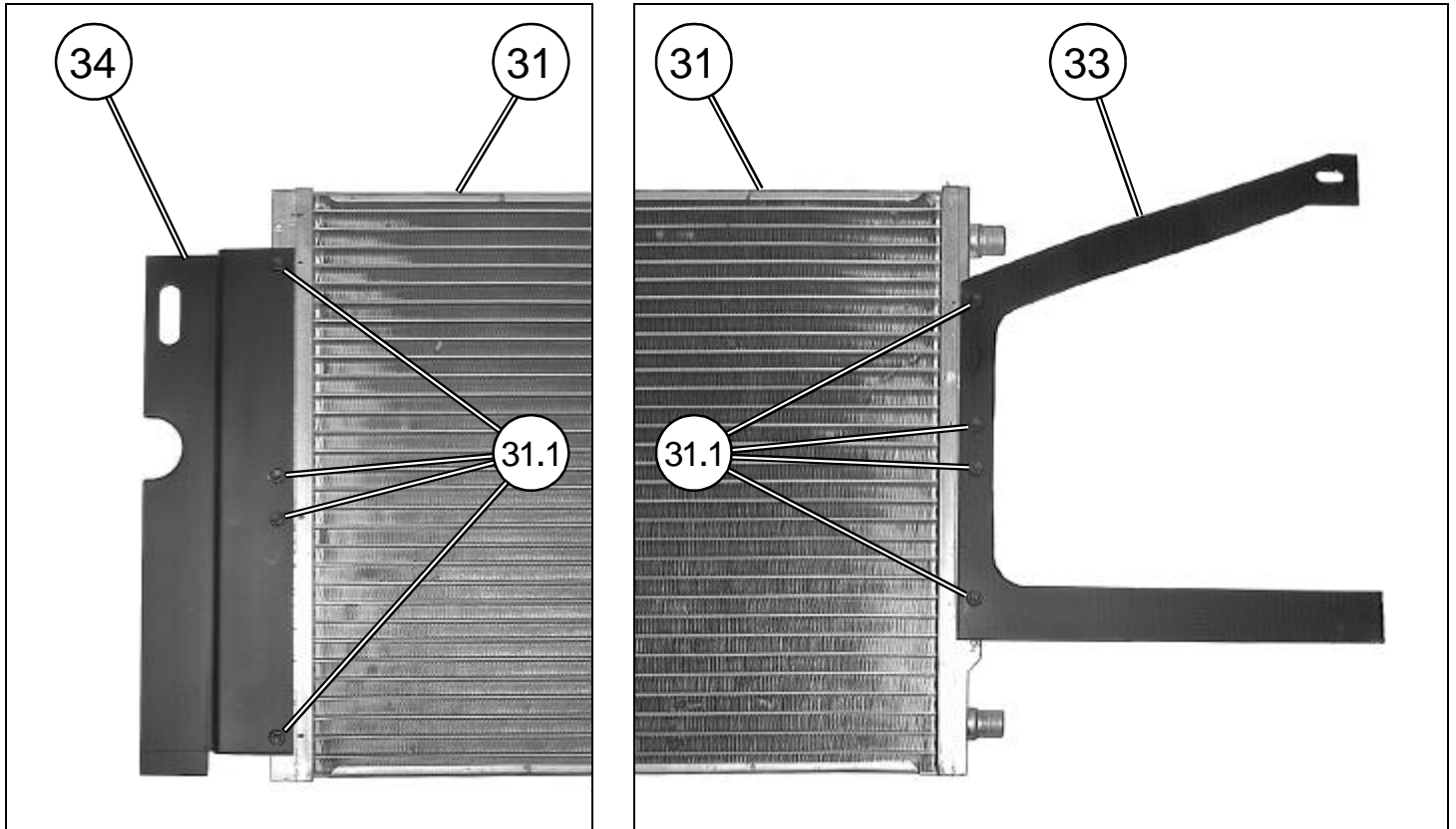

2B

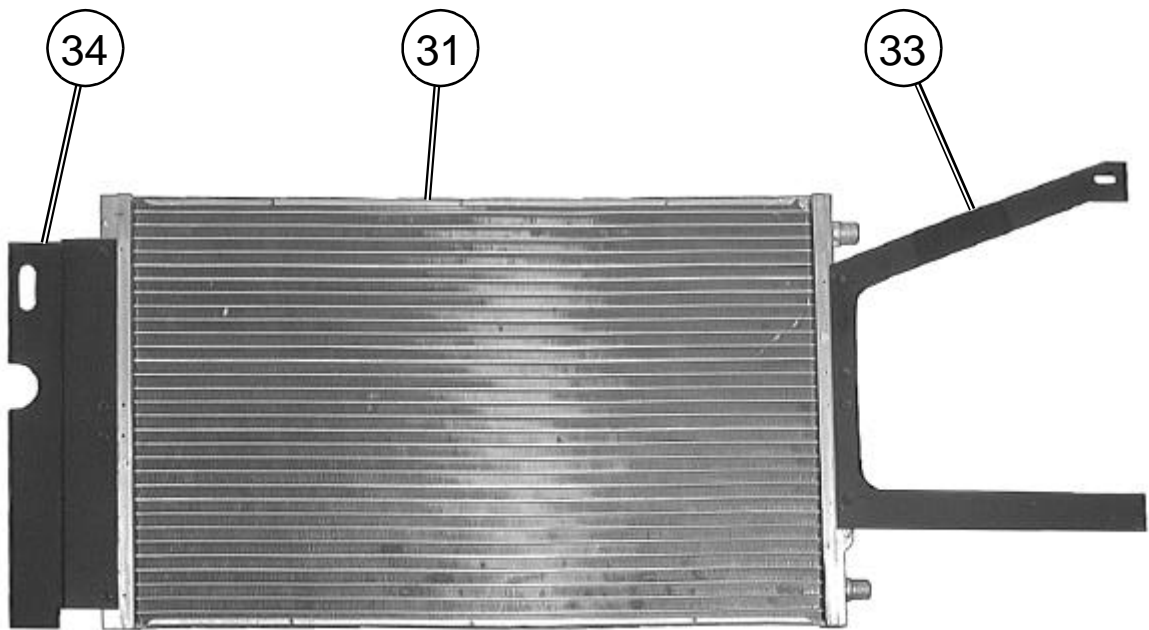

ELEMENTI DI FISSAGGIO / PIECES DE FIXATION / FIXING PARTS BEFESTIGUNGSELEMENTE / ELEMENTOS DE FIJACION		
Pos.	Tipologia / Typologie Typology / Tipologie Tipologia	Descrizione / Description Description / Beschreibung Descripción
31.1		4,2x13

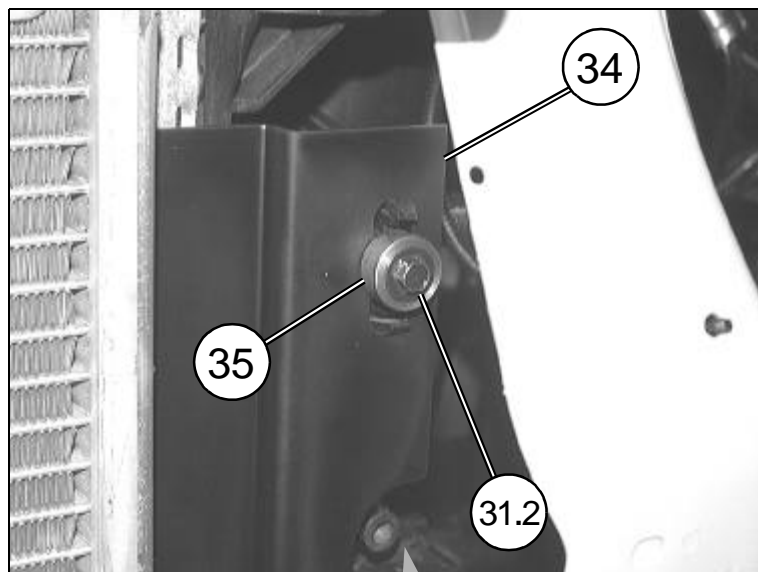

3B

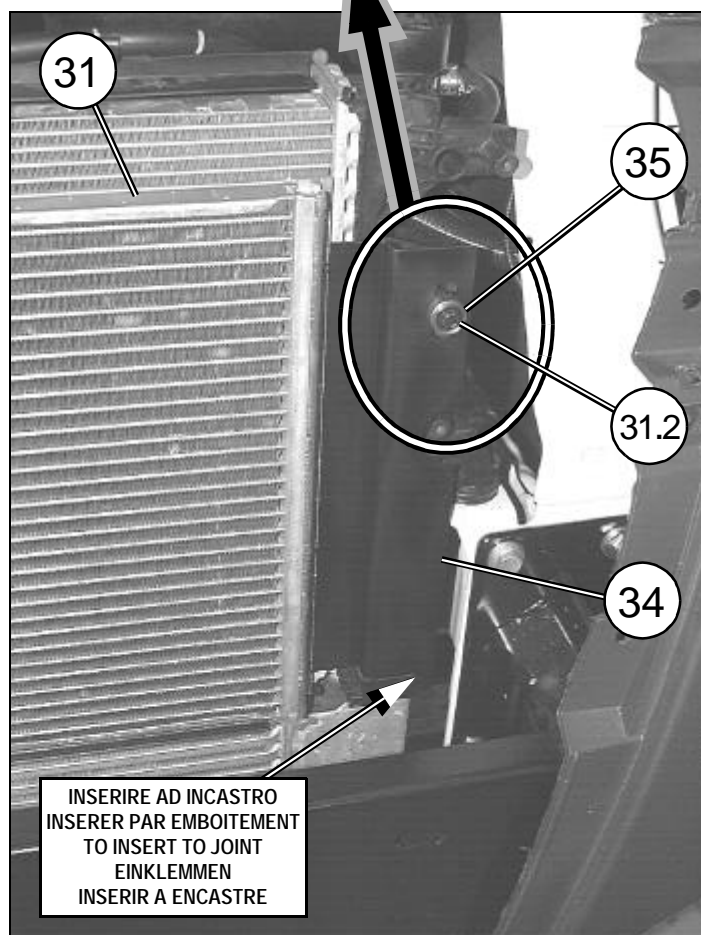
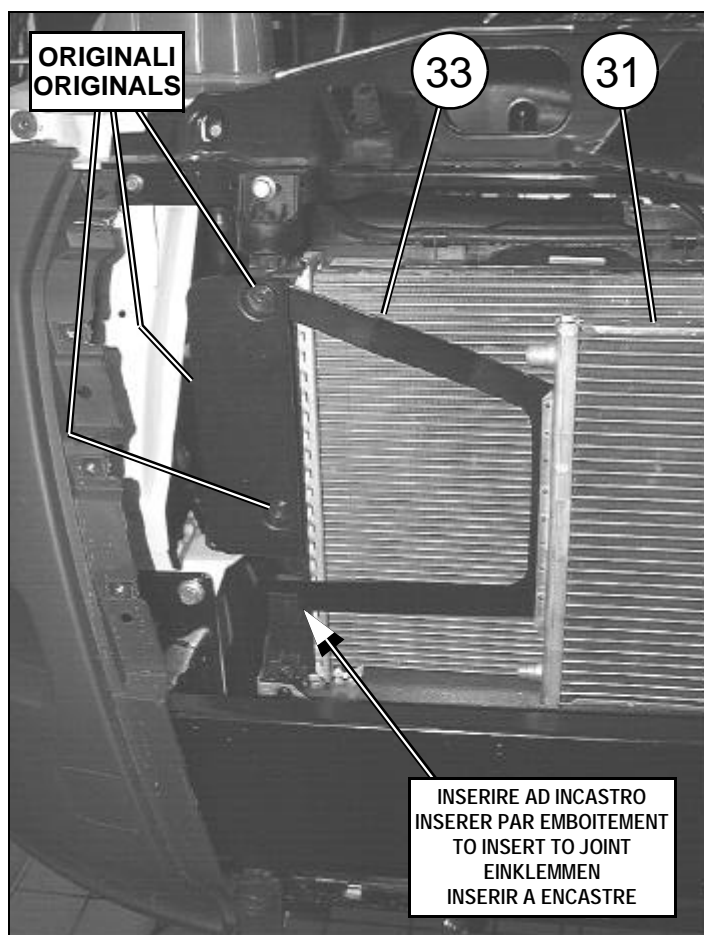

ELEMENTI DI FISSAGGIO / PIÈCES DE FIXATION / FIXING PARTS BEFESTIGUNGSELEMENTE / ELEMENTOS DE FIJACION		
Pos.	Tipologia / Typologie / Typology Tipologie / Tipologia	Descrizione / Description / Description Beschreibung / Descripción
31.2		6x20

4B

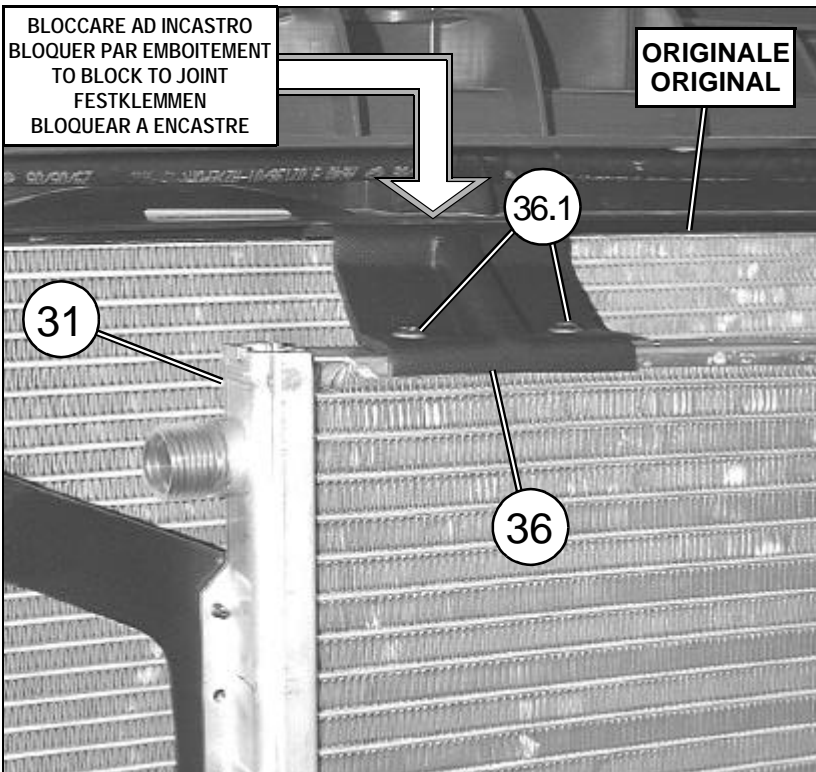
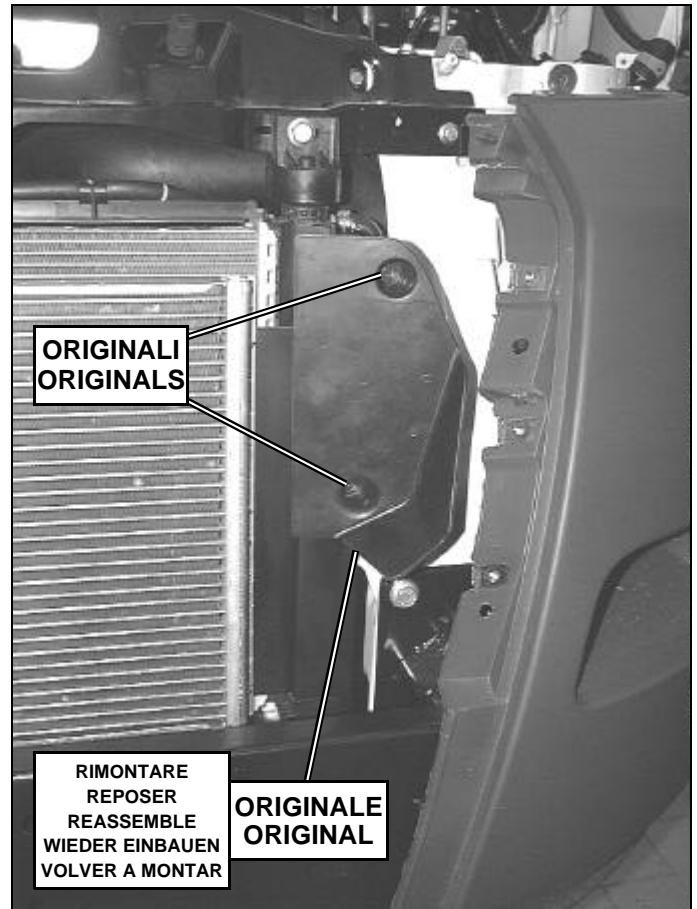

5B

ELEMENTI DI FISSAGGIO / PIECES DE FIXATION FIXING PARTS / BEFESTIGUNGSELEMENTE ELEMENTOS DE FIJACION		
Pos.	Tipologia / Typologie Typology / Tipologie Tipologia	Descrizione / Description Description / Beschreibung Descripción
36.1	 	4,2x9,5

**MONTAGGIO FILTRO ESSICCATORE / POSE DU FILTRE DESHYDRATEUR / RECEIVER DRIER ASSEMBLY
TROCKNERFILTER EINBAU / MONTAJE DEL FILTRO SECADOR**

MATERIALE FORNITO / MATERIEL FOURNI / SUPPLIED MATERIAL / GELIEFERTES MATERIAL / MATERIAL ABASTECIDO



Pos.	Descrizione / Description / Description Beschreibung / Descripción	Codice / Code Kode / Código
51	Filtro essiccatore	017047/1A
52	Staffa filtro	0361819/0



2C

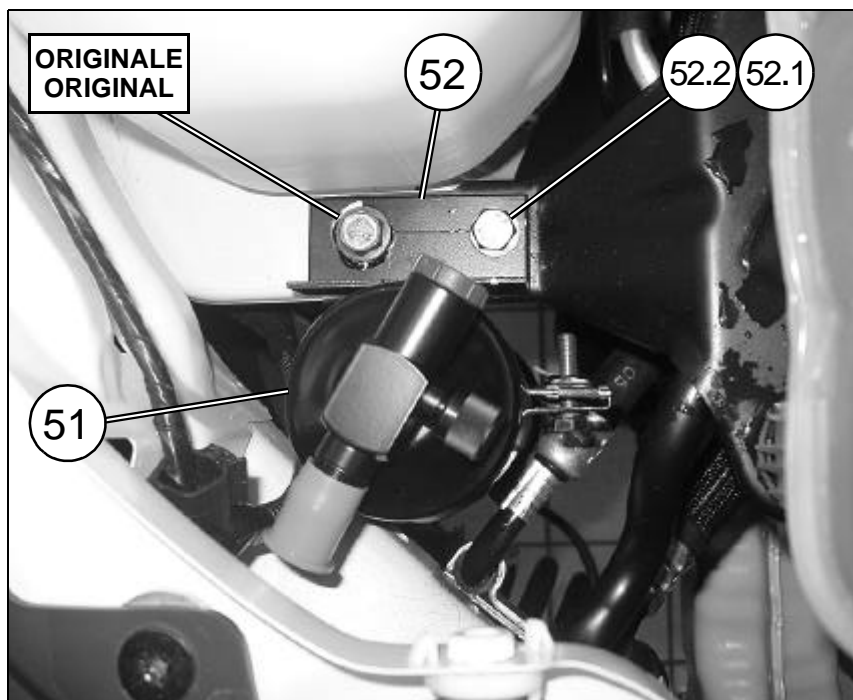

3C

**ELEMENTI DI FISSAGGIO / PIECES DE FIXATION
FIXING PARTS / BEFESTIGUNGSELEMENTE
ELEMENTOS DE FIJACION**

Pos.	Tipologia / Typologie Typology / Tipologie Tipologia	Descrizione / Description Description / Beschreibung Descripción
52.1		M8x20
52.2		φ8

MONTAGGIO COMPONENTI A.C. NELL'ABITACOLO (parte evaporante-comandi)
POSE DES COMPOSANTS A.C. DANS L'HABITACLE (évaporateur-commandes)
A.C. COMPONENTS ASSEMBLY IN THE PASSENGER COMPARTMENT (evaporator-controls)
EINBAU DER KLIMAANLAGEN-BESTANDTEILE IM WAGENINNEREN (Seite der Verdampfersteuerung)
MONTAJE COMPONENTES A.C. EN EL HABITACULO (parte evaporador-mandos)

MATERIALE FORNITO / MATERIEL FOURNI / SUPPLIED MATERIAL / GELIEFERTES MATERIAL / MATERIAL ABASTECIDO

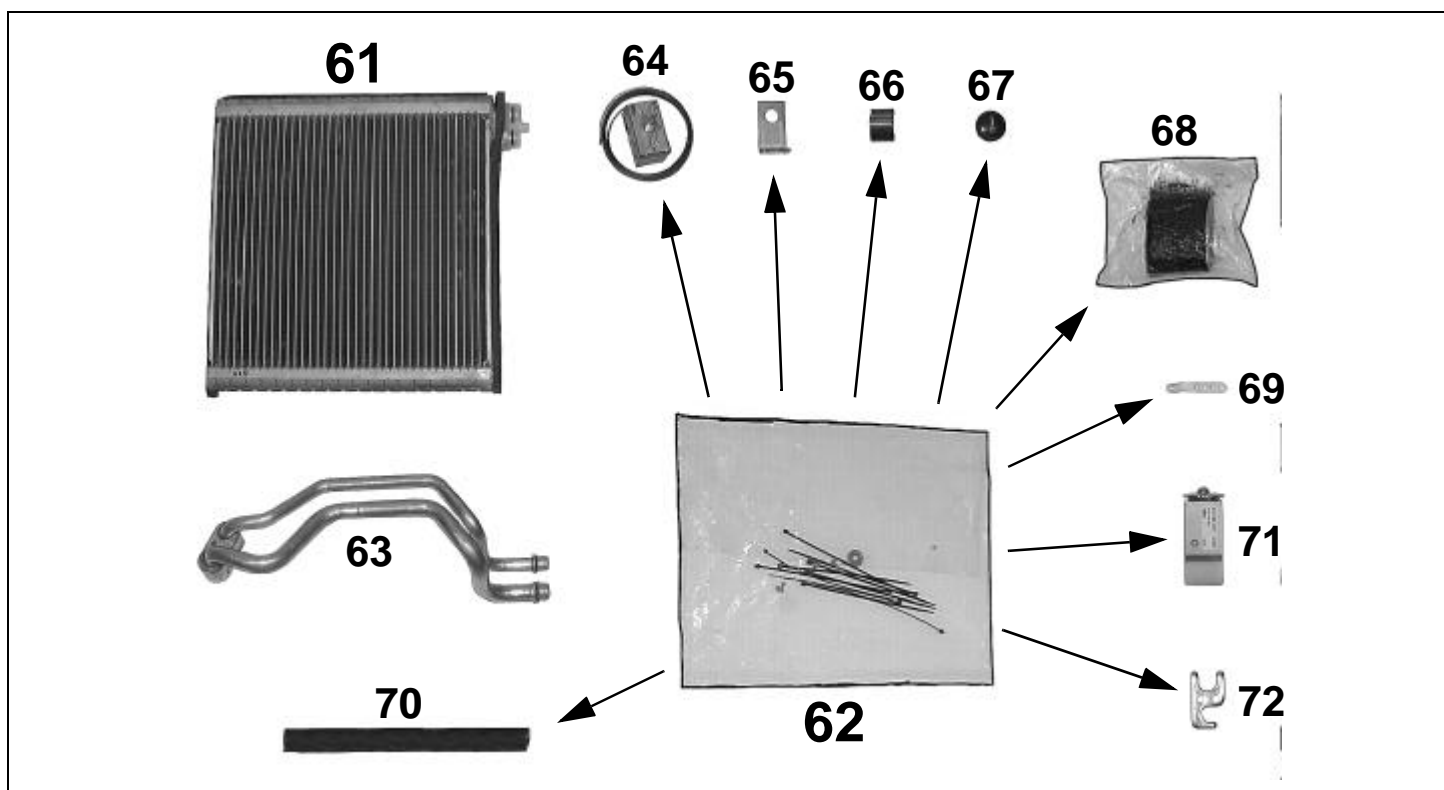

1D

Pos.	Descrizione / Description Description / Beschreibung Descripción	Codice / Code Kode / Código
61	Batteria evaporante	052803/0
62	Sacchetto accessori	029932/0
63	Distributore tubi gas	043357/0
64	Termostato	0682242/0
65	Staffa supporto termostato	068165/0
66	Molla fissaggio bulbo	069180/0A

Pos.	Descrizione / Description Description / Beschreibung Descripción	Codice / Code Kode / Código
67	Pomello	068003/0A
68	Mastice anticondensa	070001/0
69	Fascetta LOOPING	069100/0
70	Tubo scarico condensa	011003.1
71	Valvola di espansione	058027/0A
72	Flangia fissaggio valvola	043060/0A

(I)

NOTA: Le operazione di montaggio all'interno dell'abitacolo, del gruppo evaporatore, dei componenti elettrici e dei comandi A.C., sono illustrate nel manuale di istruzioni fornito nel Kit A...., che completa la fornitura dell'impianto aria condizionata, a cui si rimanda l'installatore.

(F)

NOTE: Les opérations de montage à l'intérieur de l'habitacle, du groupe évaporateur, des composants électriques et des commandes A.C., sont illustrées dans le manuel d'instructions fourni avec le Kit A...., qui complète la fourniture de l'équipement air conditionné, auquel on renvoie l'installateur.

(GB)

NOTE: The operations involved in installing the evaporating unit, electrical components and A.C. commands in the passenger compartment are illustrated in the instruction manual supplied with the Kit A.... completing the supply of the air conditioning system. See that manual for further information.

(D)

ANMERKUNG: Die Einbauschritte der Verdampfereinheit, der elektrischen Einbauteile und der Klimaanlagesteuerung im inneren des Fahrzeuraums, sind gemäß dem Anleitungshandbuch, das mit dem Einbaukit A..... geliefert wurde auszuführen, dieses vervollständigt die Lieferung der Klimaanlage und beinhaltet Anweisungen an die sich der Installateur strikte zu halten hat.

(E)

NOTA: Las operaciones de montaje, en el habitáculo, del grupo evaporador, de los componentes eléctricos y de los mandos A.C., están indicadas en el manual de instrucciones abastecido en el Kit A...., que completa el abastecimiento de la instalación del aire acondicionado y que el instalador debe consultar.

**COLLEGAMENTO TUBI GAS / RACCORDEMENT DES TUYAUX GAZ / GAS PIPE CONNECTION
KAELEMITTELSCHLAUCHVERBINDUNG / CONEXION TUBOS GAS**

MATERIALE FORNITO / MATERIEL FOURNI / SUPPLIED MATERIAL / GELIEFERTES MATERIAL / MATERIAL ABASTECIDO

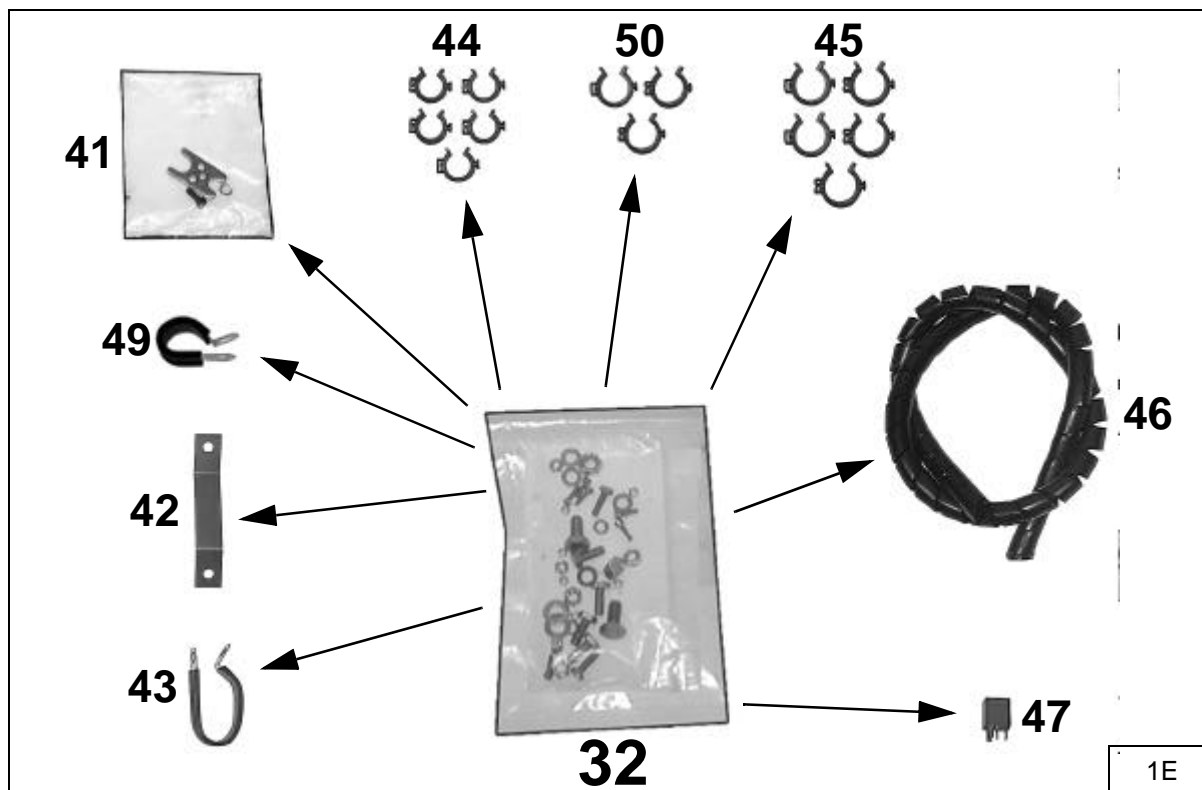

Pos.	Descrizione / Description / Description Beschreibung / Descripción	Codice / Code Kode / Código
32	Sacchetto accessori	0231784/0
41	Sacchetto flangia	043066/1A
42	Staffa di supporto tubi gas	0361820/0
43	Fascetta in gomma	069241/1
44	Fermatubo ϕ 18	069635/0
45	Fermatubo ϕ 24	069637/0
46	Protezione a spirale	070494/0
47	Relay interruttore	0681911/0
49	Fascetta in gomma	069033/0A
50	Fermatubo ϕ 22	069636/0

TUBI GAS / TUYAUX GAZ / GAS PIPE / KAELEMITTELSCHLÄUCHE / TUBOS GAS

Descrizione / Description / Description Beschreibung / Descripción	Codice / Code / Kode / Código
Tubo gas 5/16"CF (condensatore-filtro)	806E184
Tubo gas 5/16"FE (filtro-evaporatore)	806E185/1
Tubo gas 13/32"CC (compressore-condensatore)	808E186/1
Tubo gas 1/2"EC (evaporatore-compressore)	810E187

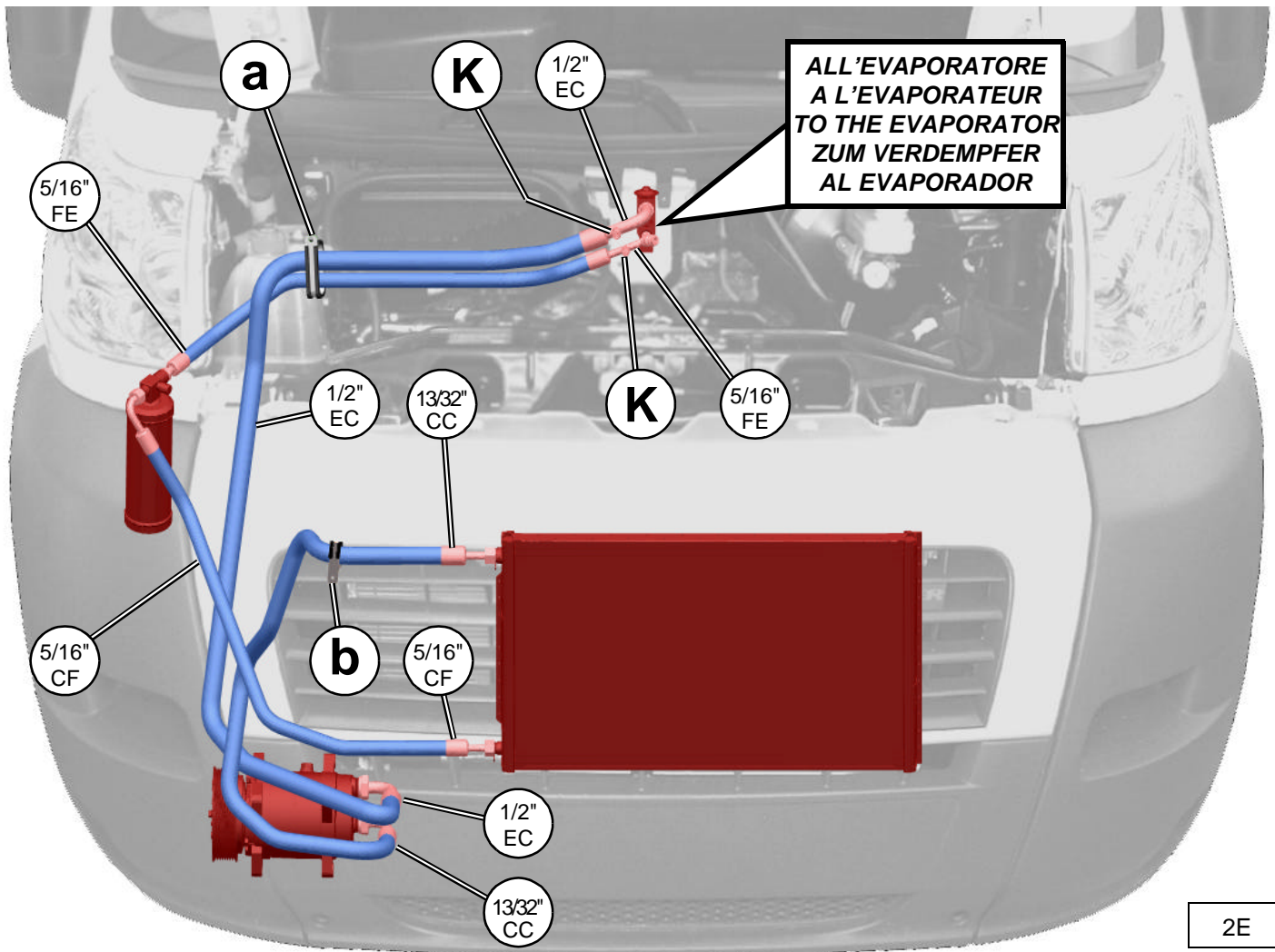

2E

R134a
Kg.0,500 (±0,025)

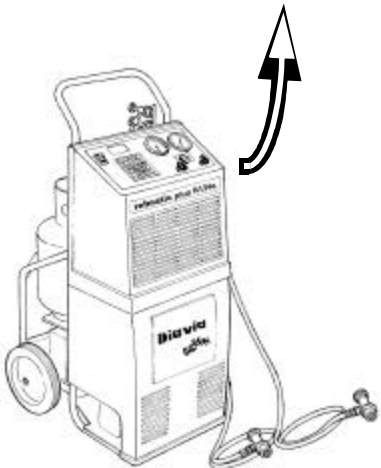

(I)
Vista complessiva passaggio tubi gas nel vano motore.

Alle posizioni "a-b" sono evidenziati i punti di fissaggio tubi alla vettura, descritti in particolare nelle figure che seguono. Alle posizioni "K" sono evidenziate le valvole di carica dell'impianto aria condizionata predisposte sui raccordi tubi gas 1/2"EC e 5/16"FE.

(F)
Vue d'ensemble du passage des tuyaux gaz dans le compartiment moteur.

Les points de fixation des tuyaux à la voiture, décrits en détail sur les figures qui suivent, sont mis en évidence aux positions "a-b". Aux pos. "K" on a indiqué les soupapes de charge équipement A/C prévues sur les raccords des tuyaux gaz 1/2"EC et 5/16"FE.

(GB)
General view of the gas hoses in the engine compartment.

Positions "a-b" indicate the points for securing pipes to the vehicle, described in detail in the following figures. At the position "K", the A/C system charge valves prepared on the 1/2"EC and 5/16"FE gas hoses couplings are shown.

(D)
Gesamtansicht des Durchgangs der Kältemittelschläuche im Motorraum.

Bei den Positionen "a-b" sind die Befestigungspunkte der Schläuche am Fahrzeug hervorgehoben. An den Positionen "K" sind die Füllventile der Klimaanlage an den Anschlüssen der 1/2"EC und 5/16"FE-Kältemittelschläuchen hervorgehoben.

(E)
Vista total paso tubos gas en el compartimiento motor.

En las posición "a-b" se evidencian los puntos de sujeción de los tubos al coche, descritos detalladamente en las figuras que siguen. En las posiciones "K" están evidenciadas las válvulas de carga de la instalación aire acondicionado preparados en los racord tubos gas 1/2"EC y 5/16"FE.

3E

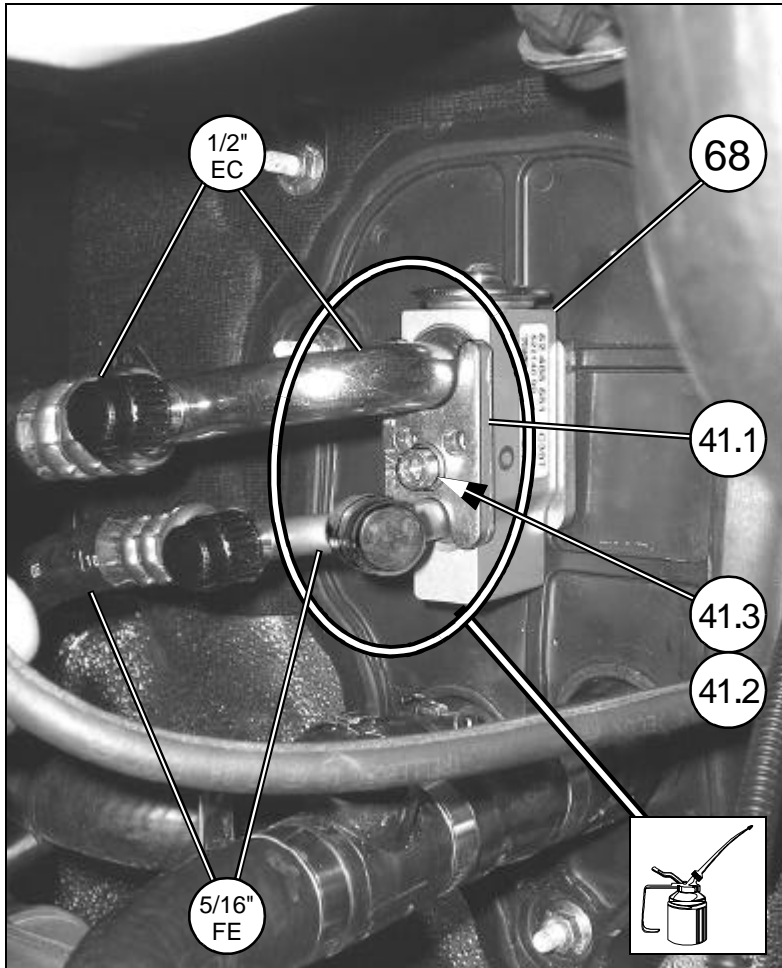

ELEMENTI DI FISSAGGIO / PIECES DE FIXATION FIXING PARTS / BEFESTIGUNGSELEMENTE ELEMENTOS DE FIJACION			
Pos.	Tipologia Typologie Typology Tipologie Tipologia	Descrizione Description Description Beschreibung Descripción	Codice Code Code Codigo
41.1		Flangia tubi gas	043061/1A
41.2		M6x16	-
41.3		φ6	-

4E

ELEMENTI DI FISSAGGIO / PIECES DE FIXATION FIXING PARTS / BEFESTIGUNGSELEMENTE ELEMENTOS DE FIJACION		
Pos.	Tipologia / Typologie Typology / Tipologie Tipologia	Descrizione / Description Description / Beschreibung Descripción
42.1		M6x20
42.2		φ6
42.3		M6

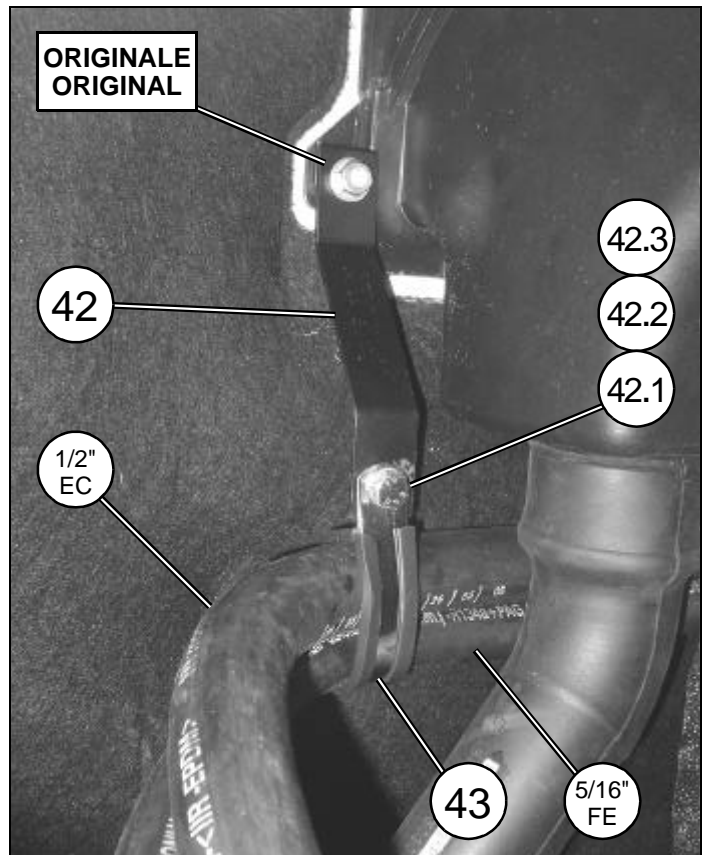

5E

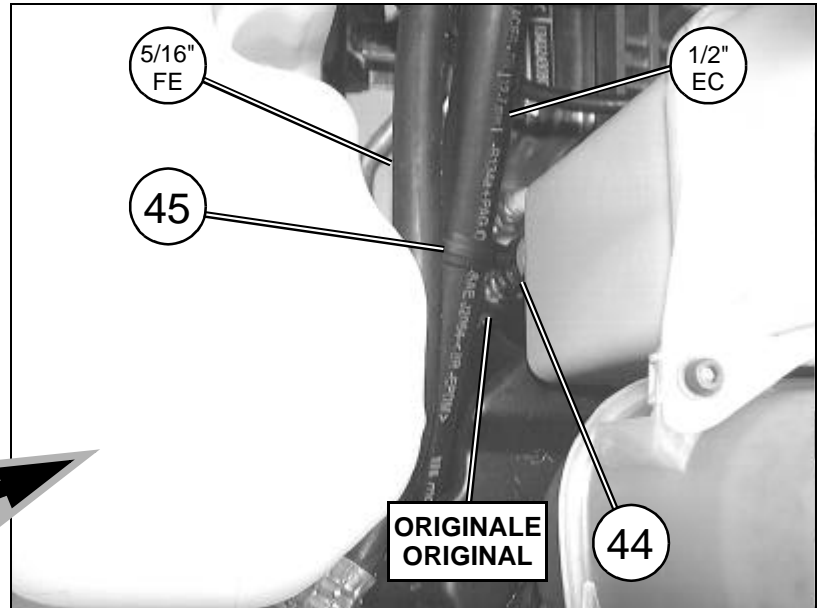
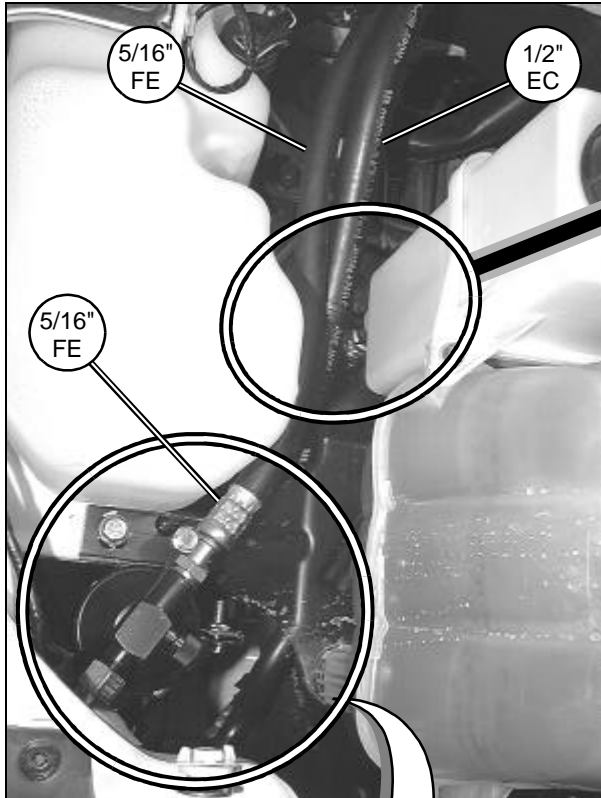

ELEMENTI DI FISSAGGIO / PIECES DE FIXATION FIXING PARTS / BEFESTIGUNGSELEMENTE ELEMENTOS DE FIJACION			
Pos.	Tipologia / Typologie Typology / Tipologie Tipologia	Descrizione / Description Description / Beschreibung Descripción	Codice / Code Code / Código
44		Fermatubo ϕ 18	069635/0
45		Fermatubo ϕ 24	069637/0

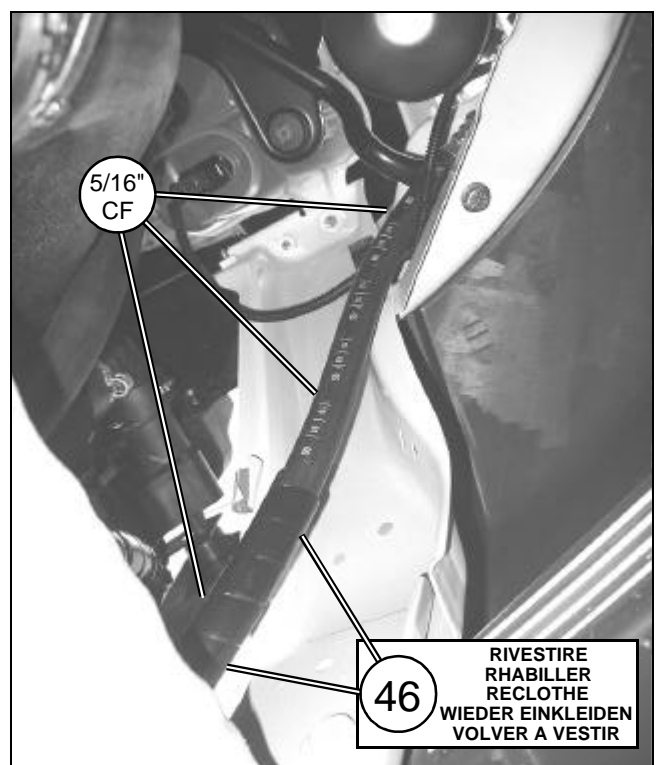
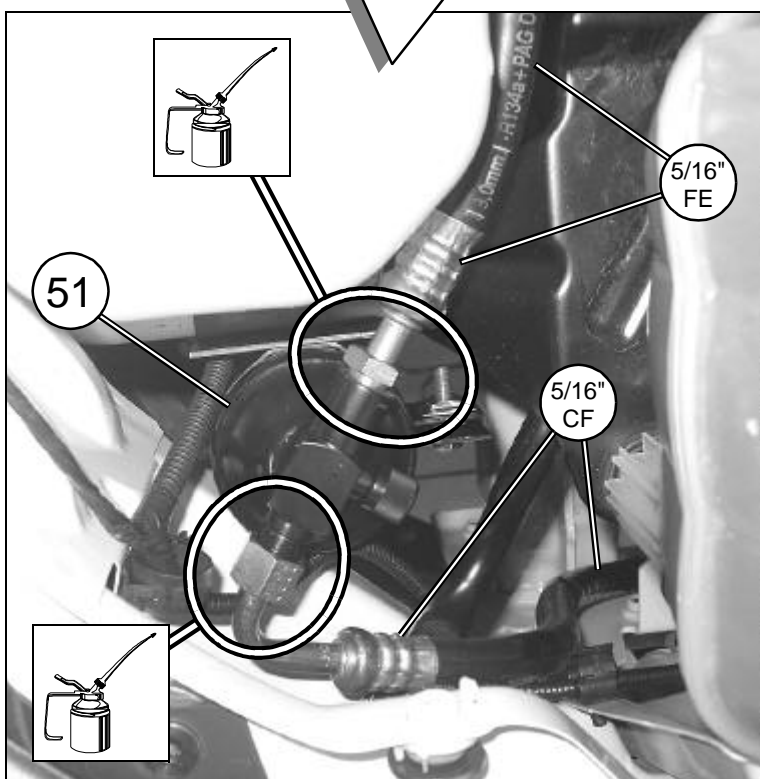

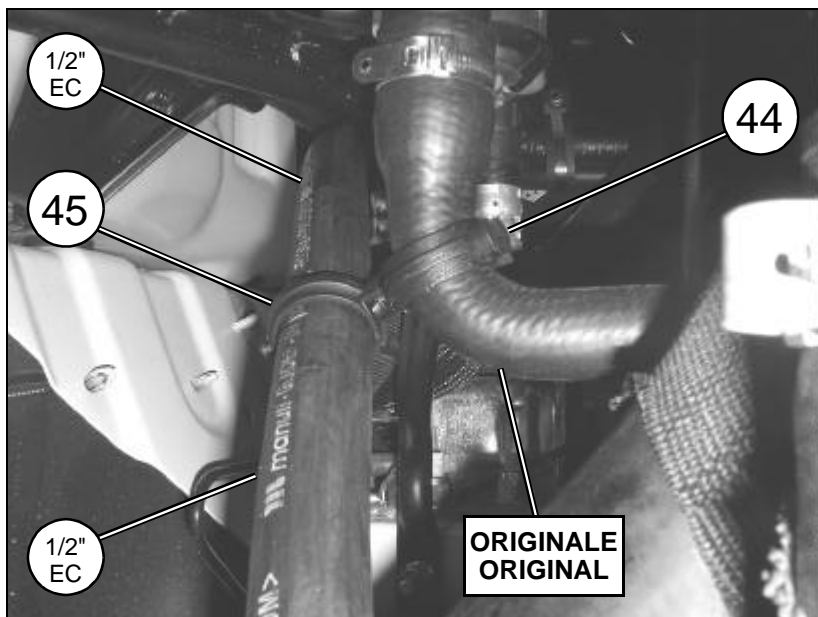

6E

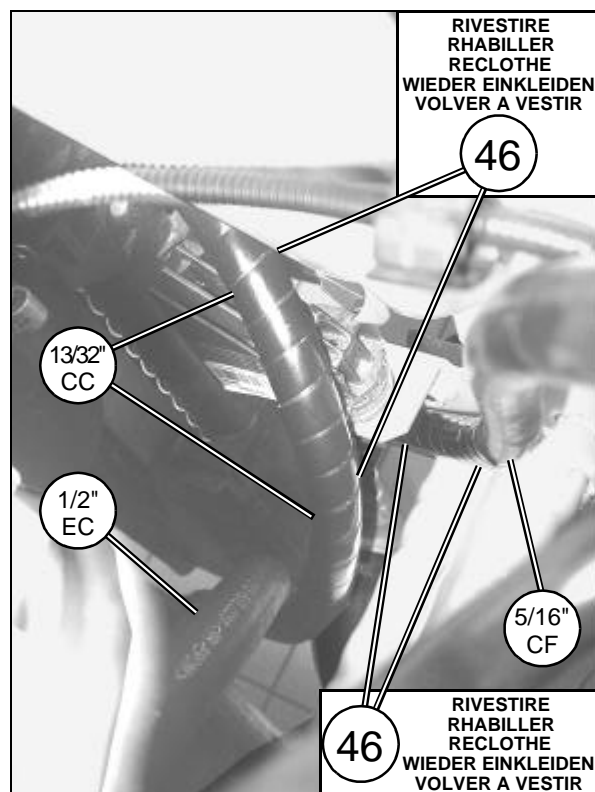

ELEMENTI DI FISSAGGIO / PIECES DE FIXATION FIXING PARTS / BEFESTIGUNGSELEMENTE ELEMENTOS DE FIJACION			
Pos.	Tipologia / Typologie Typology / Tipologie Tipologia	Descrizione / Description Description / Beschreibung Descripción	Codice / Code Code / Código
44		Fermatubo ϕ 18	069635/0
45		Fermatubo ϕ 24	069637/0
		Fascetta a strappo	-

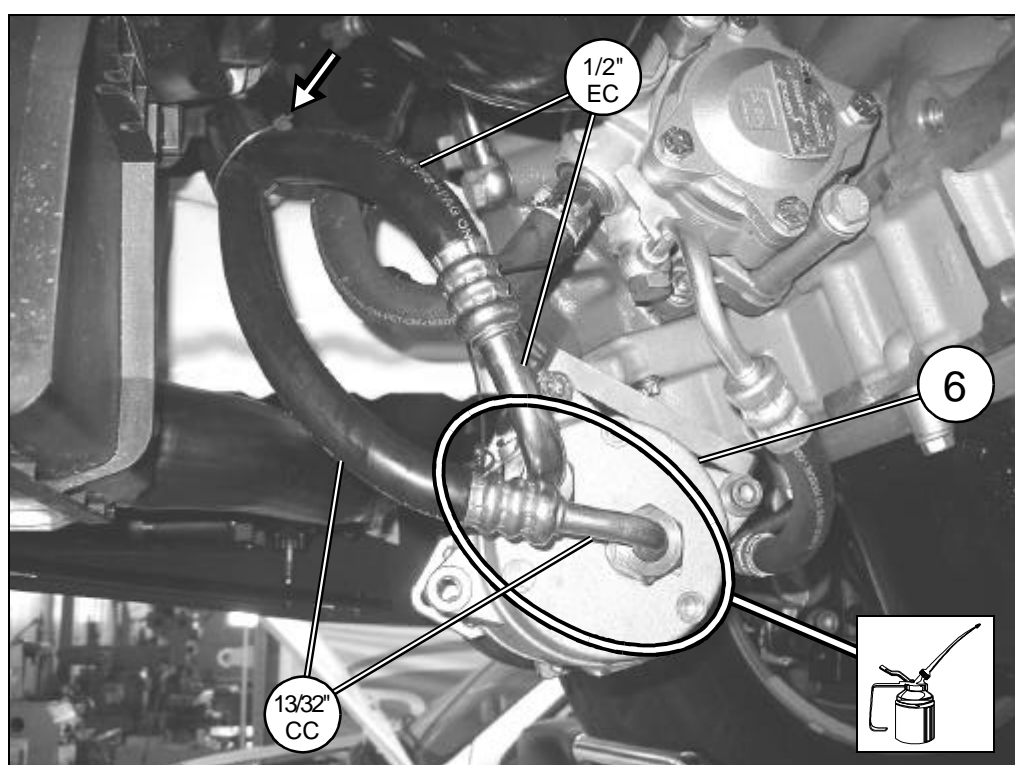

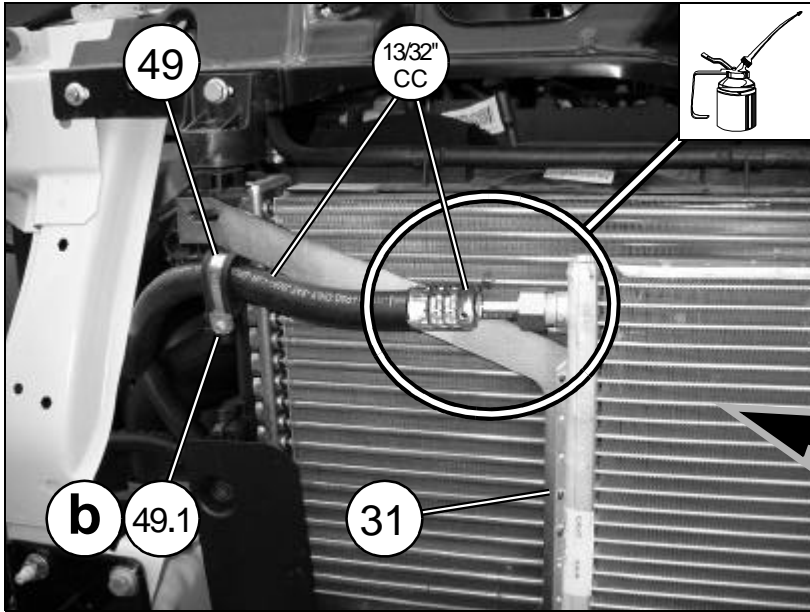

7E

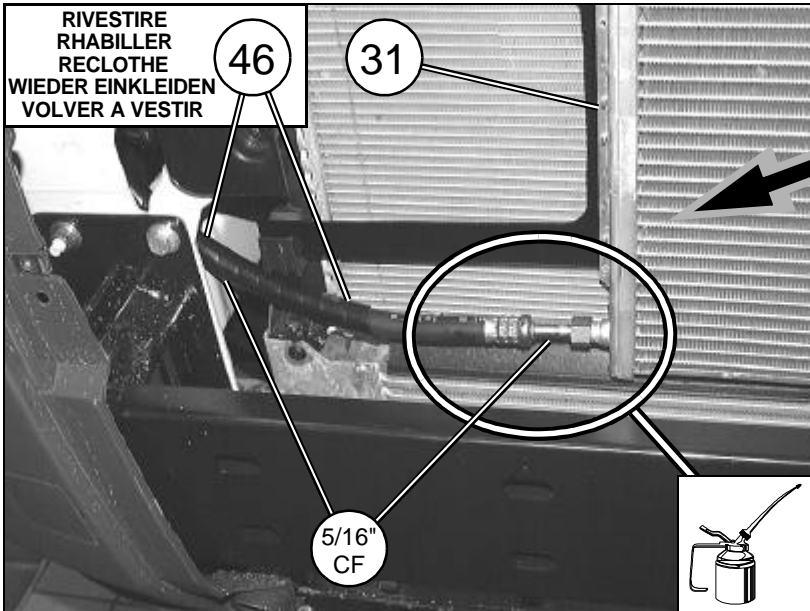
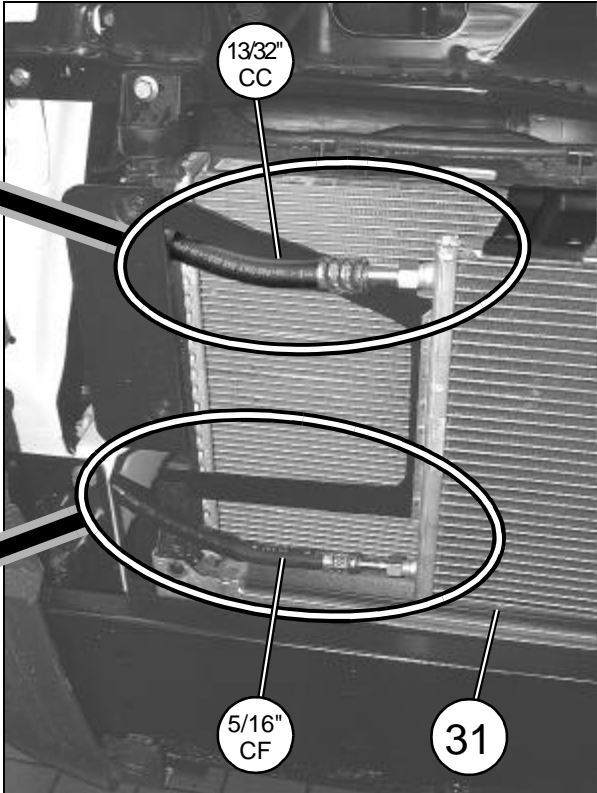

ELEMENTI DI FISSAGGIO / PIECES DE FIXATION FIXING PARTS / BEFESTIGUNGSELEMENTE ELEMENTOS DE FIJACION		
Pos.	Tipologia / Typologie Typology / Tipologie Tipologia	Descrizione / Description Description / Beschreibung Descripción
49.1		4.2x16

(I)
DELPHI ITALIA mira ad un costante miglioramento dei propri prodotti. La Casa si riserva il diritto di apportare in qualunque momento e senza preavviso modifiche ai modelli e ai componenti descritti in questa pubblicazione per ragioni di natura tecnica o commerciale. Per ulteriori informazioni rivolgersi al servizio assistenza DELPHI.

(F)
DELPHI ITALIA vise à une amélioration constante des ces produits. La maison se réserve le droit d'apporter, à tout moment et sans préavis, des modifications aux modèles et aux composants décrits dans cette publication pour des raisons d'ordre technique ou commerciale. Pour d'ultérieures informations s'adresser au service d'assistance DELPHI.

(GB)
DELPHI ITALIA focuses on constant upgrading of its products. The Manufacturer reserves the right to modify the models and components described in the present publication at any time for technical or commercial reasons and without prior notice. For further information, contact DELPHI technical services.

(D)
DELPHI ITALIA ist stets bestrebt die eigenen Produkte zu verbessern. Die Herstellerfirma behält sich das Recht vor, aus technischen oder Verkaufsgründen, zu jeder Zeit und ohne vorherige Ankündigung, Abänderungen an den Modellen und den in dieser Veröffentlichung beschriebenen Einbauteile vorzunehmen. Für weitere Informationen bitten wir Sie, sich an unseren DELPHI Kundendienst zu wenden.

(E)
DELPHI ITALIA aspira a un constante mejoramiento de su producción. La Fábrica se reserva el derecho de aportar en cualquier momento y sin preaviso modificaciones a los modelos y los componentes descritos en esta publicación por razones técnicas o comerciales. Para ultiores informaciones dirigirse al servicio asistencia DELPHI.

VENDITA E SERVIZIO
VENTE ET SERVICE

VERKAUF UND SERVICE
SALE AND SERVICE

DELPHI ITALIA AUTOMOTIVE SYSTEMS S.r.l.
Stabilimento Molinella

Via Nobili, 2 40062 Molinella (Bologna)-Italy
Telefono (0039) 051.6906111

Fax (0039) 051.6906287

Email: diavia.service@delphi.com

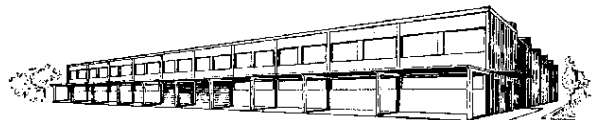

MOD. SCHFI360

IV / '08
(2006)

Questa pubblicazione è stata curata da DELPHI ITALIA-Diavia
Ufficio Fitting Instructions - Stabilimento Molinella

This publication has been edited by DELPHI ITALIA-Diavia
Fitting Instructions Office - Factory Molinella